



DUCTED FUME HOOD

BFSD-201 BFSD-202

INDEX

1. Unpacking, Installation and Debugging	2
<hr/>	
1.1 Unpacking of Main Body	2
1.2 Unpacking of Base Cabinet	5
1.3 Accessories Checking	6
1.4 Installation Conditions and Operating Environment	7
1.5 Installation	8
1.6 Inspection after Installation	11
2. User Instructions	12
<hr/>	
2.1 Functions	12
2.2 Product Structure	14
2.3 Control Panel	16
2.4 Instructions of Operation	17
2.5 Regular Maintenance	19
2.6 Wiring Diagram	21
3. Trouble Shooting and Labels	23
<hr/>	
3.1 Common Failures and Solutions	23
3.2 Label Description	26
4. Warranty	27
<hr/>	

1. Unpacking, Installation and Debugging

Please firstly check whether the packing box is in good condition. If the packing box is damaged, please take photos and contact the freight carrier. We are not responsible for shipping damages

1.1 Unpacking of Main Body

Choose a proper unpacking method according to the actual situation.

1.1.1 For wooden box

a) Method 1 Necessary tools for unpacking: Electric drill with hexagon dead M8



Figure 1
Method 2 Use M8 wrench to unpack



Figure 2
 The following diagram demonstrates quick unpacking procedures (Picture 3). Remove the screws shown in the diagram below, then move the wooden pieces to right and left.

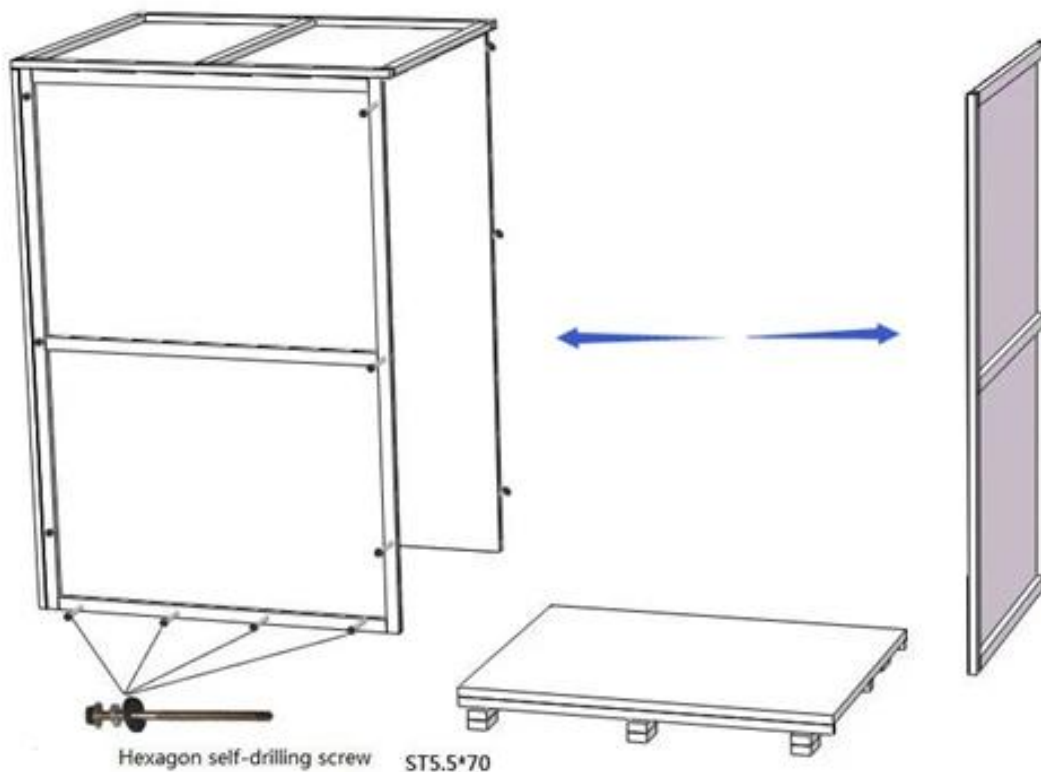

Figure 3

1.1.2 For cartoon box

Use scissor to cut the packing tape, take off the package cover, then move up the box body.



Figure 4

1.2 Unpacking of Base Cabinet

Choose a proper unpacking method according to the actual situation.

1.2.1 For wooden box

Please refer to the main body unpacking method (of wooden box) in the previous pages, use M8 electric drill or M8 wrench to remove the screws and unpack the box.



Figure 5

1.2.2 For cartoon box

Please refer to the main body unpacking method (of carton box) in the previous pages, use scissor to cut the packing tape, take off the package cover and move up the box body.

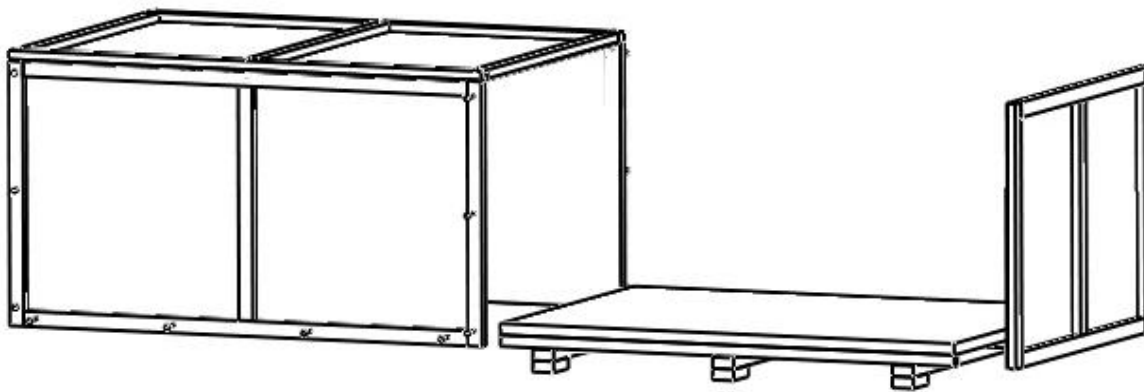

Figure 6

1.3 Accessories Checking

Accessories are placed inside the working area and base cabinet. Please refer to 1.5.6. to take out all accessories and check the completeness referring to this packing list.

Packing list (Fume Hood)

Main body box:

No	Items	Quantity
1	Main body	1 unit
2	User manual	1 pc
3	Certification of quality	1 pc
4	Inspection report	1 pc
5	UV lamp	1 pc
6	Fuse (5A)	1 pc
7	Fuse (10A)	1 pc
8	Stainless steel hexagon socket head cap screw M10x20 Stainless steel hexagon nut M10 Stainless steel flat washer 10 and spring washer 10	4 sets
9	PP water sink with accessories	1 set
10	Power cord	1 pc
11	Motor control rod	1 pc
12	Allen wrench	1 pc

Table 1

Base cabinet box:

No.	Items	Quantity
1	Base stand	1 unit
2	Exhaust duct	1 pc
3	Duct clamp	1 pc

Table 2

1.4 Installation Conditions and Operating Environment

1.4.1 Location requirements

To avoid disturbances to the Fume Hood and its operator, please follow the guideline below, while determining a suitable location for the equipment

- a) Fume Hood should not be installed in positions where they are likely to be affected by other items or equipment. Windows, doorways, fans, room air supply diffuser or ventilation outlet should be away from the Fume Hood.
- b) The distance from the front window to any circulation space or air-handling equipment should be at least 1000 mm, so as to preserve a zone undisturbed by anyone other than the operator
- c) The position of a Fume Hood should satisfy the spatial requirements (e.g. vision, lighting and convenience of access) of the operator and personnel working nearby.
- d) When a Fume Hood is installed on a bench top, the leading edge should be flush with or slightly overhanging the edge of the bench top.

1.4.2 Environment requirements

- a) Only applicable to indoor operation
- b) Ambient temperature: 15°C~35°C
- c) Relative humidity: ≤75%
- d) Atmospheric pressure range: 70 kPa~106 kPa

1.4.3 Electrical requirements

- a) Electrical parameters: consistent with the rated voltage of the Fume Hood (See 2.1.4 Technical parameters and 2.1.5 Performance index)
- b) Power supply need to be grounded (Judging method: test the live wire and the neutral wire of the main socket with multimeter. The voltage between live and ground should equal to the voltage of local electrical grid, and the voltage between neutral and ground should equal to 0. Otherwise, the power supply is not grounded correctly.)
- c) Test the voltage stability before using. If the voltage is unstable, use a voltage regulator to adjust. Otherwise, the control panel and transformer may be easily damaged

1.5 Installation

1.5.1 Remove all the package materials

1.5.2 Check the surface of the base cabinet and the main body to make sure there is no scratch, deformation or foreign bodies

1.5.3. Move the whole equipment as close as possible to the final installation place.



NOTE: Do NOT turnover, disassemble or slant the cabinet during transportation.

1.5.4 Position the base cabinet to the final location where an appropriate power supply is nearby; and brake the caster to stabilize the base cabinet

1.5.5 Make sure the voltage and frequency of power supply is same as the required value which is shown on the label. Take out the power cord from the packaging box and connect it with the female power cord connector on the main body. Plug in the other end to connect a power supply

1.5.6 Press the "" button on the control panel to power on the equipment. Afterwards, press the "



" button to raise the front window, take out the accessories from the operating area and remove the work table as shown in the picture below. Lastly, power off the equipment and prepare for installation.

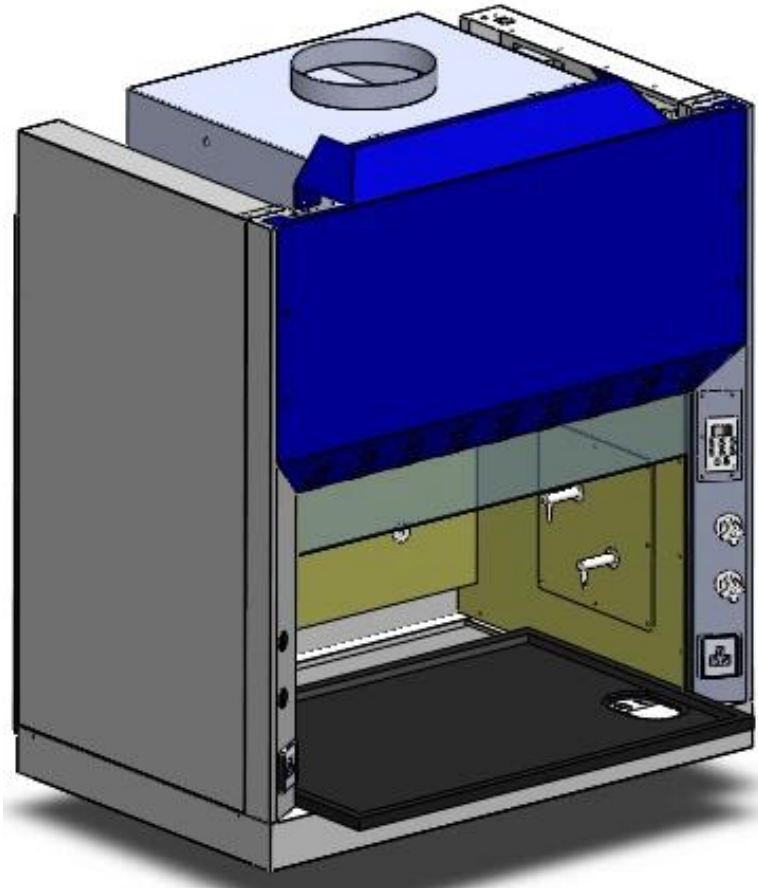

Figure 7

1.5.7 Connect base cabinet with main body

a) Lift the main body and place it on the base cabinet. Make sure each side is in alignment. Besides, please also make sure the mounting holes of bolt (as shown in Picture 9) at the bottom of the main body are in alignment with the holes on the top plate of the base cabinet

b) Make sure the main body and base cabinet are stable enough to prevent side-slip. Open the doors of the base cabinet and take out the components from the accessory bag

Stainless steel hexagon socket head cap screw M10x20

Stainless steel hexagon nut M10

Stainless steel flat washer 10 and spring washer 10

Insert the hexagon socket head cap screws (M10x20) into the holes at the bottom of the main body (refer to the Picture 8). These screws should pass through the main body and the base cabinet. Use flat washer 10, spring washer 10 and nut M10 to fasten the screws and nuts. Make sure the base cabinet is well connected with the main body.

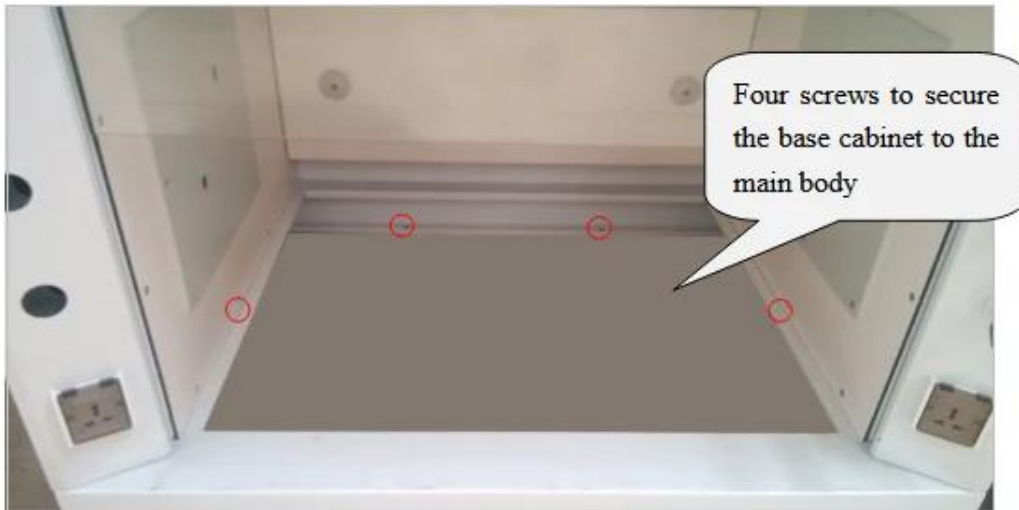

Figure 8

1.5.8 Installation of water tap and gas tap

Insert the work table and mount the water sink on the reserved sink hole.

Connect the laboratory water pipe and gas pipe (inflow) with the lower end of the taps.

Pass the drainpipe (provided) through the reserved hole at the side of the base cabinet (refer to Picture 10) and connect it with the sewer pipe in the laboratory room (water sink and drainpipe have been connected in factory)

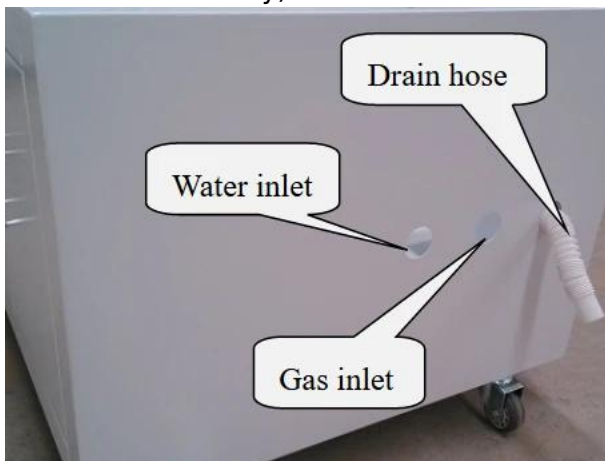

Figure 9

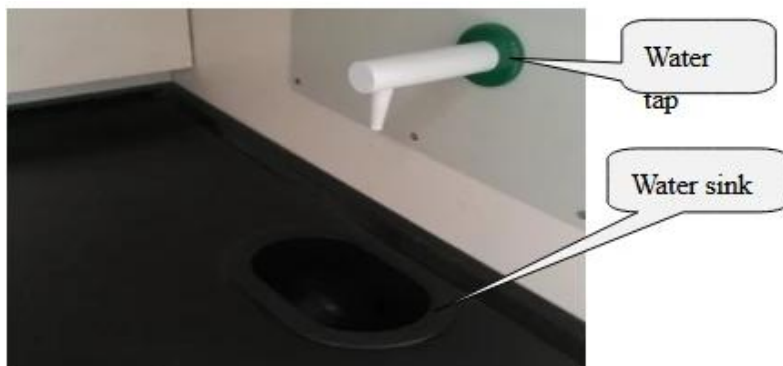

Figure 10

1.5.9 Installation of exhaust duct

Take out the duct clamp and the exhaust duct. Put the clamp on the exhaust duct and then connect the exhaust duct with the air exhaust outlet on top of the Fume Hood. Afterwards, use Slotted screwdriver to

fasten the duct clamp firmly. The other end of the exhaust duct should be fixed outside the laboratory room and in the open air.

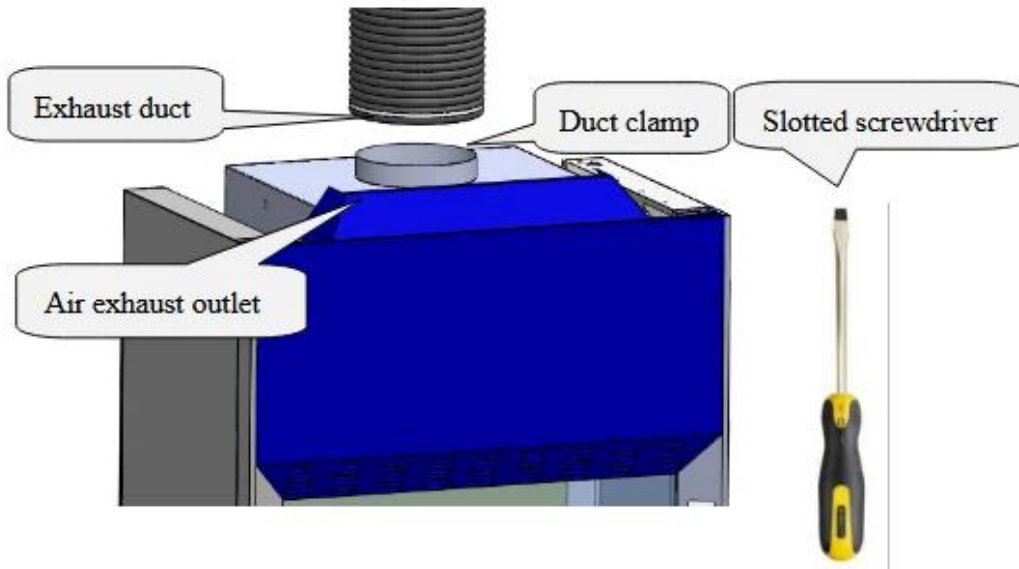

Figure 11

1.6 Inspection after Installation

Refer to this table and follow the instruction in 2.4.2, check the following items after powering on the Fume Hood.

Checking Items	Normal working status
Power status	Equipment could be powered on/switched off when press the power button
Fan	Runs normally after pressing the Fan button; speed could be adjusted by pressing the adjusting button
Front window	Front window could be moved smoothly by pressing the UP and DOWN buttons
Fluorescent lamp	Lamp lights up after pressing button
UV Lamp	Lamp lights up after pressing button
Socket	Use multimeter to test voltage output after pressing the socket button

Table 3



NOTE: Please contact Biobase technical department or agent for inspection or trouble shooting when problems could not be solved. Methodology of trouble shooting is stated in the After-sale Service Manual.

2. User Instructions

2.1 Functions

2.1.1 Product concept

This product belongs to Fume Hood. Fume Hood is a kind of negative pressure ventilation system for protecting operator and laboratory environment. Room air flows inward from the front opening of the Fume Hood and is consistently ventilated by the extract blower. Therefore, contaminated fumes, vapors, toxic gasses, aerosol and corrosive substance which are probably generated during experiments could be prevented from spreading to the operator or into the laboratory room. In addition, the polluted air could be purified by the active carbon filter (optional) before exhausting through the duct. Thus, the outdoor environment could also be protected.



NOTE: Experiments with the use of flammable, explosive substances and strong acids or bases should NOT be conducted by this Fume Hood.

2.1.2 Operating principle/air flow pattern

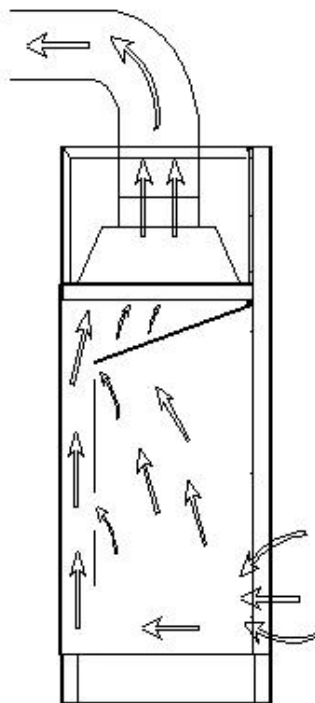

Figure 12

2.1.3 Protected object

The primary goal of the Fume Hood is to protect operators and laboratory environment from exposure to infectious aerosol and toxic fumes which may be generated from the reaction during experiments.

2.1.4 Technical parameters

Model Parameter	BFSD-201	BFSD-202
Rated Voltage AC	220V±10% 110V±10%	220V±10% 110V±10%

Rated Frequency	50 Hz 60Hz	50 Hz 60Hz
External Dimension (W*D*H)	1040*800*2200 mm	1240*800*2200 mm
Working Zone Dimension (W*D*H)	820*670*730 mm	1020*670*730 mm
Power Supply Consumption	400 W	400 W
Inflow Velocity	0.3~0.8m/s	0.3~0.8m/s
Maximum Opening	520mm	520mm
UV Lamp Consumption	20W	20W
Fluorescent Lamp Consumption	T5 8W	T5 12W
Noise	≤70dB(A)	≤70dB(A)

Table 4



NOTE: a) Power supply consumption includes the consumption loaded at working zone, which should not exceed 500W.

b) Biobase reserves the right to make changes in future product design, without reservation and without notification to its users.

2.1.5. Performance index

a) Vibration amplitude

The net vibration amplitude, at a range of frequency from 10 Hz to 10 KHz, would not exceed 5 μm (rms)

b) Illumination

The average illumination would not less than 400 lux. Tested real illumination would not less than 350 lux

c) Electrical performance

Dielectric Withstand Test: the Fume Hood would not breakdown in 5s when the voltage increases by 1390V (AC) within 5s

Ground resistance ≤0.1Ω

2.2 Product Structure

2.2.1 Structural composition of Fume Hood

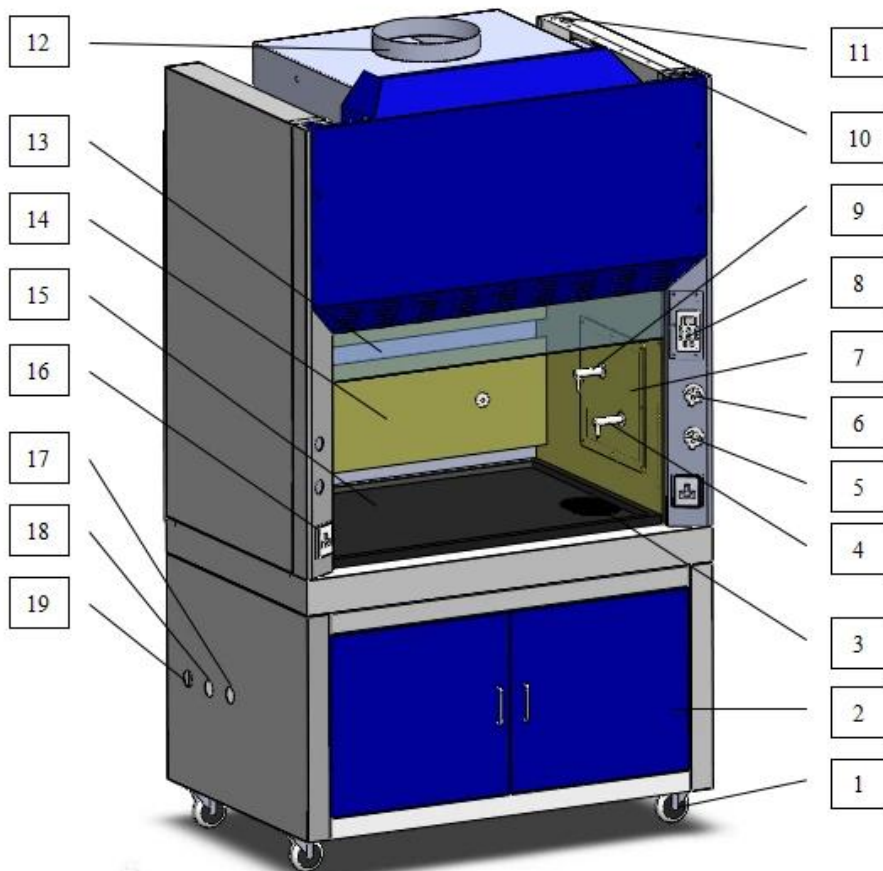

Figure 13

1. Caster
2. Base cabinet
3. Water sink
4. Water tap
5. Water tap control knob
6. Gas tap control knob
7. Access panel
8. Control panel
9. Gas tap
10. Power socket
11. Fuse holder
12. Exhaust outlet
13. Front window
14. Phenolic compact laminate
15. Work table
16. Socket
17. Gas inlet
18. Water inlet
19. Drain hose

2.2.2 Structure introduction

a) Driving system of front window

Driving system consists of tubular motor, front window and hauling mechanism (hauling sash)

b) UV lamp

The entire work zone could be sterilized effectively by the UV lamp located at the top of work zone.

Emission of 253.7 nanometers could ensure the most efficient decontamination.

c) Fluorescent light

The Fume Hood is equipped with LED lamp tube, which ensures the standard requirement of average illumination (400 lux) is met. The measured value at any point inside the working zone should be greater than 350 lux.

d) Socket

Socket, located at the two sides beside the front opening, could supply electricity power for devices used in experiments and could be controlled by the  button.



NOTE: Please make sure the total load of sockets should be $\leq 500W$.

e) Fuse protector

Fuse holders are installed on the top right of the equipment (refer to Figure 13).

Fuse of live wire is inside the female power cord connector. Socket (working zone) fuse holder and neutral wire (power source) fuse holder is beside the female connector. The specification of each fuse tube complies with the label right below the fuse holder. Please refer to the label when replace the fuse tube.

f) Structure

i. External case body adopted 1.0 mm cold-rolled steel in double layer structure with electrostatic coating and rust-proof treatment. The structural strength and stability are enhanced.

ii. Inner wall of work area is fully made of Phenolic Compact Laminate which provides corrosion resistance as well as attractive appearance; work table is made of solid chemical resistant laminate which is easy to clean and wash.

iii. Fume hood front window adopted 5 mm toughened glass.

iv. Control panel adopted soft-touch buttons and microprocessor control system that make the operation easily to be controlled

v. The electronic control system could prevent overload of the circuit and electric shock, stabilize the performance, protect the equipment and extend the use life of the Fume Hood.

vi. The sockets (at working zone) adopted non-flammable PC material that is specialized for laboratory use

2.3 Control Panel

2.3.1 Soft touch buttons

Main functions could all be executed by pressing the relevant button. There are totally 8 common buttons on the control panel (refer to Picture 14). The indicator light above each button shows the working status of the relevant function. The small LED display shows the speed level of the blower.

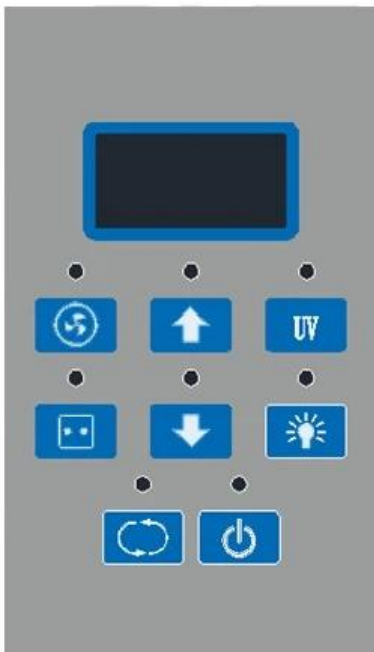













Figure 14

-  Power button, the main switch of the Fume Hood
-  Fluorescent lamp, press to turn on the light, interlocked with UV lamp
-  UV lamp, only works when both the blower and the fluorescent lamp are turned off
-  Front window up, press and hold to continuously raise the window
-  Blower (Fan), press to turn on the blower, interlocked with UV lamp
-  Front window down, press and hold to continuously lower the window
-  Socket power, press to activate the sockets in the working zone
-  Adjust fan speed, press to adjust the speed of the blower (fan) from F1 to F9

2.3.2 Control of the front window

The height of the front window could be adjusted by pressing the  and  buttons. The window will be moved continuously when pressing the button and it will stop moving immediately when the button is released. Please make sure the height of the front window is within the safety height range (520 mm).

2.3.3 Control of the fan speed

The blower (fan) could be turned on by pressing  button (only when the UV lamp is turned off). The speed of the fan could be adjusted by pressing  button. 9 speed levels could be selected. The relevant speed level would be displayed on the LED screen. When turn off the blower or power off the Fume Hood, the level of fan speed is memorized by the equipment and would be resumed when turn on the blower again.

2.3.4 UV sterilization

UV light could be turned on by pressing the UV button. Please make sure the window is fully closed before starting UV sterilization. Interlock function was adopted between UV light and the blower/fluorescent light. UV light could be automatically turned off when either the blower or fluorescent

light is turned on. During sterilization, people should leave the room for safety of eyes and skin.

2.4 Instructions of Operation

2.4.1 Normal Operation Notice

- a) Make sure input voltage is correct and stable. The rated load of main power socket should be higher than cabinet consumption. Plug must be well grounded.
- b) The equipment should be powered off and unplugged before doing any replacement of parts, such as UV lamp and fluorescent lamp.
- c) The front window is made of explosion-proof toughened glass. In order to keep the front window clean and clear, please wipe it by wet soft cloth and keep it away from hydrofluoric acid
- d) The air deflector and other internal accessories should be cleaned according to the use of the Fume Hood
- e) The air duct and the blower of the Fume Hood should be cleaned and maintained regularly in a proper way
- f) Fume Hood should be placed in a position where there should be no other equipment or machine within 150mm of the front window
- g) Do NOT place any soft or tiny materials (such as soft tissue) on the work table during the operation to prevent breakdown of the blower causing by sucking those materials
- h) The packed Fume Hood should be stored in a warehouse with relative humidity no more than 75% and temperature lower than 40°C. The warehouse should have good ventilation performance without acid, alkali or other corrosive gases
- i) The maximum storage period is one year. A performance inspection should be done if the storage period exceeds one year



NOTE: BIOBASE WILL NOT BE LIABLE FOR ANY RISK OR DAMAGE ARISING FROM YOUR FAILURE TO APPROPRIATELY OPERATION THE FUME HOOD!

2.4.2 Operation Process



- a) Connect to a suitable power supply
- b) Power on the Fume Hood by pressing the power switch under the working zone, the LED screen would

be lighted as "  "

- c) Press the POWER button  on the control panel to enable all functions (fluorescent lamp, UV lamp, blower, socket, front window). The LED screen would display the accumulated operating time of the blower (if the optional active carbon filter is ordered and equipped, the LED screen would display the accumulated operating time of the filter).





NOTE: The displayed figure needs to multiply by 10 to get the actual operating time. The unit is hour.

- d) Press the UP button  to raise the front window to a proper height. Please refer to 2.1.4 for the maximum opening of the front window
- e) Press the FAN button  to turn on the blower. The LED screen would display the speed level of the fan memorized from the last time of operation. The indicator light above the FAN button would be turned on to show the working status of the blower. Make sure the blower runs at least FIVE minutes before starting any experiment.



NOTE: The blower would be turned off automatically when the UV lamp is turned on.

f) Press the LAMP button  to turn on the fluorescent light. The indicator light above the button would be turned on to show the working status of the fluorescent light. Please refer to the actual condition of illumination in the laboratory room to decide whether the fluorescent light is needed.

g) After finishing the experiment, turn off the blower and the fluorescent light and press the DOWN button  to close the front window

h) Press the UV button  to turn on the UV light. The indicator light above the button would be turned on to show the working status of the UV lamp. Please make sure the sterilization is at least 30 minutes. Press the UV button again to turn off the UV lamp. Please refer to the actual situation to decide whether sterilization is needed.



NOTE: a) When the UV light is in working status, people should leave the room in order to protect skin and eyes.

b) UV lamp should be replaced regularly according to the frequency of use. The service life of UV lamp is about 600 hours.

i) Press the POWER button to power off the Fume Hood after all functions have been turned off. Press the power switch to disconnect power before plugging out.

j) If power failure happened during the operation causing by interruption of electricity supply or dropping off of plug or other abnormal situations, the equipment could memorized the current operating status automatically and resume those functions when power on again.

2.5 Regular Maintenance

A detailed daily record of operating time is recommended, as the accumulated using time will directly affect the plan of maintenance.



NOTE: a) To avoid electric shock, please cut off ALL power before applying maintenance for the equipment!

b) The blower and the exhaust duct should be inspected and maintained regularly.

c) The accumulated operating time is a vital factor of deciding when the maintenance is needed. A comprehensive record of operation is highly recommended to be taken down after each time of operating.

2.5.1. Overall maintenance period

Comprehensive maintenance is recommended to be carried out for a period of 1000 working hours or one year; weekly and monthly maintenance is also required to optimize the performance of the Fume Hood.

2.5.2. Preparation before maintenance

Material needed: soap, hot water or warm water, a piece of soft cotton cloth, a piece of dry cloth or towel, rubbing alcohol or other disinfectants, 1:100 dilution of household bleach, abrasive household cleaners, sterile water.

2.5.3. Clean the equipment surface

a) Clean the surface of working zone

Wipe the entire surface with a soft cotton cloth which has been soaked with concentrated liquid soap. Afterwards, wipe off the foam with another cotton cloth or towel which has been soaked with clean hot/warm water. At the end, wipe the entire surface with a dry cotton cloth or towel rapidly.

For the contaminated or dirty work surface and sump, use 70% rubbing alcohol or other disinfectant to wipe.



NOTE: Disinfectants used for wiping should not damage the 304 stainless steel.

b) Clean the external surface and front window

Use a piece of soft cotton cloth or towel with non-abrasive household cleanser to wipe the surface.

2.5.4. Maintenance methods

a) Weekly and monthly maintenance

i. Clean the external surface and front window (refer to 2.5.3.b)

ii. (Not necessary) Use towel with 70% rubbing alcohol or 1:100 dilution of household bleach to wipe the working table, the inner face of front window and the inner wall surface of the working area (exclude the top wind grid). Use another towel with sterile water to wipe those areas to erase the remains of chlorine

iii. Check the various functions of the Fume Hood

iv. Record down the maintenance result

b) Annual maintenance

i. Check the two lifting belt (sash) of the front window tubular motor, make sure both of them are well connected to the motor with same tightness

ii. Check the UV lamp and fluorescent lamp, replace it if needed

iii. Apply for overall performance test of the cabinet annually to ensure that the safety performance has met the requirements. User is responsible for testing costs

iv. Record down the maintenance result

2.5.5. Storage conditions

Fume Hood should be stored in a warehouse with relative humidity no more than 75% and temperature lower than 40°C. The warehouse should have good ventilation performance without acid, alkali or other corrosive gases. Storage period shall not exceed one year. Fume Hood stored for more than one year needs to be unpacked and checked before selling and using. Only the tested and qualified safety cabinet could be sold.

Fume Hood Replacement Part List BFSD-201

Part Name	Specification
Fuse tube	5A\10A
UV lamp holder	T8 LG13-01A
Fluorescent lamp	T5 8W
UV lamp	T6 20W
UV lamp ballast	TL8-20W
Blower	FH320A
Main control panel	fume hood main control panel
Front window glass	880*700*5
Active carbon filter(optional)	660*500*30

Fume Hood Replacement Part List BFSD-202

Part Name	Specification
Fuse tube	5A\10A
UV lamp holder	T8 LG13-01A

Fluorescent lamp	T5 12W
UV lamp	T6 20W
UV lamp ballast	TL8-20W
Blower	FH320A
Main control panel	fume hood main control panel
Front window glass	1080*700*5
Active carbon filter(optional)	660*500*30

Table 5

2.6 Wiring Diagram

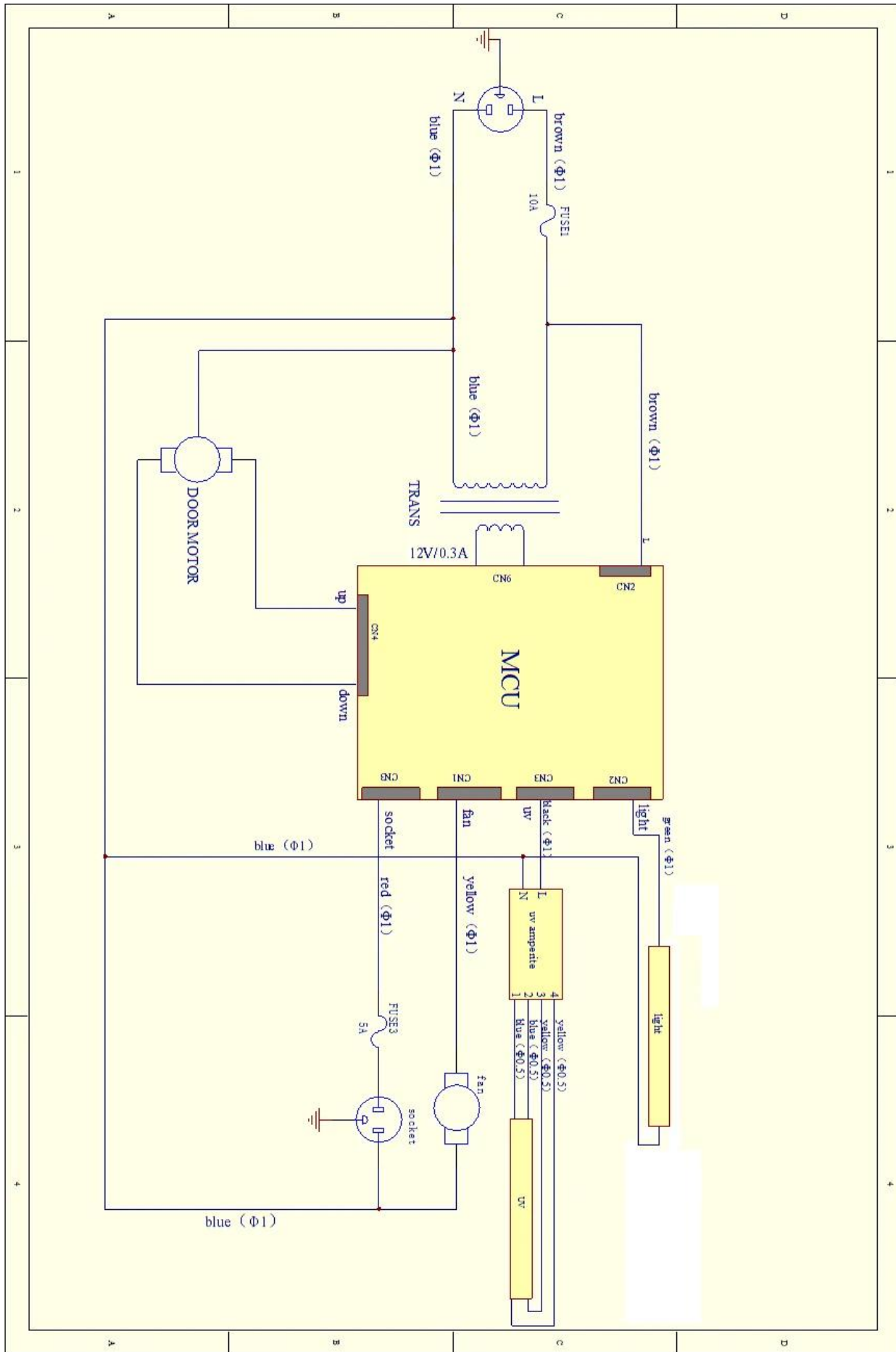

Figure 15

3. Trouble Shooting and Labels

3.1 Common Failures and Solutions

3.1.1 Trouble shooting

Please confirm that the power is well connected, the power cord, the circuit and the fuses are in good condition (without any damage) before trouble shooting the following problems.

Failures	Checking Part	Suggestion
Fluorescent lamp fail to work	Fluorescent lamp tube	Replace the fluorescent lamp tube
	Circuit	Check the circuit
	Control panel	Replace the control panel
UV lamp fail to work	Fluorescent lamp and blower	Make sure the fluorescent lamp and the blower are turned off
	Lamp holder	Connect the tube and lamp holder tightly
	Ballast	Replace the ballast
		Checking according the fluorescent lamp failure step, then confirm.
Button fail to work	Control panel	Make sure the power is well connected and the fuse is in good condition
		Check if the button is broken
		Make sure the connecting wire is well connected
		Replace the control panel
Blower fail to work	Blower	Replace the blower if it is defective
	Circuit	Check the circuit
	Control panel	Replace the control panel
No electricity in socket	Socket fuse	Check if the socket fuse is broken
	Socket	Check if the socket is broken
	Circuit	Check the circuit
	Control panel	Replace the control panel
Front window fail to work	Transmission part	Check the transmission connection and lead rail
	Motor of front window	Check the front window motor
	Circuit	Check the circuit
	Control panel	Replace the control panel

No electricity in equipment	Power supply	Check whether the power supply is well connected
	Power cord	Check whether the power cord is in good condition
	Fuse	Check if the fuse is damaged
	Potential transformer	Check whether the transformer works normally
	Control panel	Replace the control panel
Display fail to work	Signal transmission line	Check whether the signal transmission line is well connected
	Display screen	Check whether the screen is in good condition
	Control panel	Replace the control panel

Table 6



NOTE: a) The above trouble shooting methods should be done by qualified electricians under safe conditions (cut off power supply). Other components should not be removed. Risk caused by failing to follow those instructions would be responsible by user.

b) Please contact Biobase technical department if a failure could not be traced or solved. Do NOT repair the equipment without a qualified electrician.

c) The trouble shooting and repair of this equipment only could be undertaken by trained and recognized technicians.

d) Please contact Biobase technical department or agent to order required component or part. The model number and the serial number of purchased Fume Hood need to be indicated.

3.1.2. Simple accessories replacement

a) Replace the fuse

Fuse of socket and fuse of neutral wire is located on top of the equipment (refer to picture 13). For replacing the fuse, turn off the power and disconnect the plug. Use a Phillips screwdriver and rotate it anticlockwise to unscrew the fuse holder. Replace the fuse inside the fuse holder and then, use a Phillips screwdriver and rotate it clockwise to screw back the fuse holder. Live wire fuse is also located on top of the equipment, inside the female connector. For replacing the live wire fuse, turn off the power and disconnect the plug. Use a Slotted screwdriver to lever up the fuse holder to open it. Replace the fuse inside the fuse holder and then, press the fuse holder back.

The parameter of the fuse tubes in the round fuse holders are required to conform to labels, that are F5A $\phi 5 \times 20$ mm and F10A $\phi 5 \times 20$ mm.

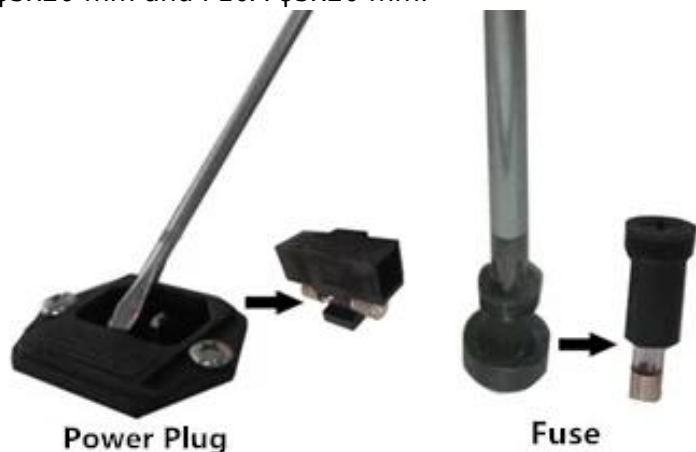

Figure 16

b) Replace fluorescent light

For replacing the lamp tube, press UP button to rise up the front window to the highest position, then turn off the power and disconnect the plug. Remove the power cord of the lamp tube refer to picture 17. Then remove the lamp tube by pulling the small slice on the tube base as shown in the Picture 17. Install a new lamp tube by pushing it in and connecting with the power cord.



Figure 17

c) Replace the UV lamp

The UV lamp tube should change regularly, for example every 600 hours. For replacing the lamp tube, press the UP button to rise up the window to the highest position, then turn off the power and disconnect the plug. Rotate the tube for 90° to remove it and then install a new UV lamp tube by rotating in reverse direction.



Figure 18

3.2 Label Description

3.2.1 Fuse label



Figure 19

a. Operating area 5A socket fuse label, located under the socket fuse holder

b. 10A power fuse label, located under the female power connector

3.2.2 Ground label



Figure 20

3.2.3 Load requirements label

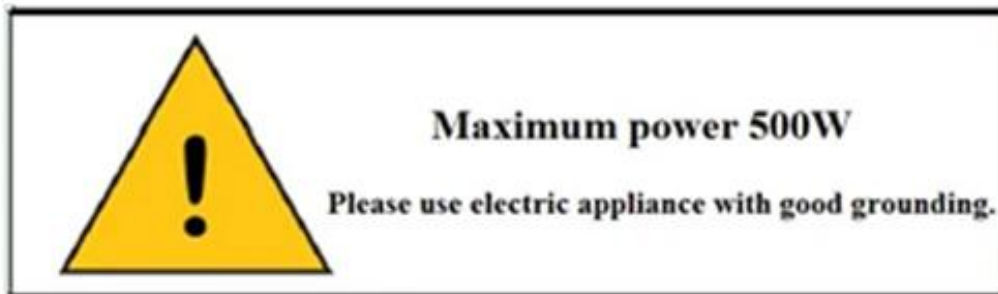

Figure 21

4. Warranty

- 4.1. Warranty is 12 months from EX-factory date (excluding consumable accessories, UV and Fluorescent lamp, fuse)
- 4.2. Biobase would not be liable for any repair of damage caused by improper operation
- 4.3. If the warranty has been expired, Biobase would still responsible for repair with relative charges
- 4.4. Life time of fume hood is 8 years from production date on the label
- 4.5. Biobase would provide equipment drawings and necessary technical data for maintenance companies or personnel trained by Biobase engineers



Warranty Declaration: One-year Warranty, Life-long Maintenance



Biolab Scientific Ltd.

Trillium Executive Center, East Tower, 675 Cochrane Dr, Markham, Ontario L3R 0B8, Canada
Email: info@biolabscientific.com | Website: www.biolabscientific.com